

Libretto di Istruzioni

Instructions Manual

Manuel d'Instructions

Bedienungsanleitung

Gebruiksaanwijzing

Manual de instrucciones

Manual de Instruções

Руководство по эксплуатации

Bruksanvisning

Brugsvejledning

KFV92 - KFV92HI

INDICE

IT

CONSIGLI E SUGGERIMENTI.....	4
CARATTERISTICHE.....	5
INSTALLAZIONE.....	6
USO.....	9
MANUTENZIONE.....	10

INDEX

EN

RECOMMENDATIONS AND SUGGESTIONS.....	11
CHARACTERISTICS.....	12
INSTALLATION.....	13
USE.....	16
MAINTENANCE.....	17

SOMMAIRE

FR

CONSEILS ET SUGGESTIONS.....	18
CARACTERISTIQUES.....	19
INSTALLATION.....	20
UTILISATION.....	23
ENTRETIEN.....	24

INHALTSVERZEICHNIS

DE

EMPFEHLUNGEN UND HINWEISE.....	25
CHARAKTERISTIKEN.....	26
MONTAGE.....	27
BEDIENUNG.....	30
WARTUNG.....	31

INHOUDSOPGAVE

NL

ADVIEZEN EN SUGGESTIES.....	32
EIGENSCHAPPEN.....	33
INSTALLATIE.....	34
GEBRUIK.....	37
ONDERHOUD.....	38

ÍNDICE

ES

CONSEJOS Y SUGERENCIAS.....	39
CARACTERÍSTICAS.....	40
INSTALACIÓN.....	41
USO.....	44
MANTENIMIENTO.....	45

ÍNDICE

PT

CONSELHOS E SUGESTÕES.....	46
CARACTERÍSTICAS	47
INSTALAÇÃO.....	48
UTILIZAÇÃO	51
MANUTENÇÃO.....	52

УКАЗАТЕЛЬ

RU

СОВЕТЫ И РЕКОМЕНДАЦИИ	53
ХАРАКТЕРИСТИКИ	54
УСТАНОВКА.....	55
ЭКСПЛУАТАЦИЯ.....	58
УХОД.....	59

INNEHÅLL

SE

REKOMMENDATIONER OCH TIPS	60
EGENSKAPER.....	61
INSTALLATION.....	62
ANVÄNDING.....	65
UNDERHÅLL.....	66

INDHOLD

DK

RÅD OG ANVISNINGER	67
APPARATBESKRIVELSE	68
INSTALLATION.....	69
BRUG	72
VEDLIGEHOJDELSE	73

RECOMMENDATIONS AND SUGGESTIONS

⚠ The Instructions for Use apply to several versions of this appliance. Accordingly, you may find descriptions of individual features that do not apply to your specific appliance.

INSTALLATION

- The manufacturer will not be held liable for any damages resulting from incorrect or improper installation.
- The minimum safety distance between the cooker top and the extractor hood is 650 mm (some models can be installed at a lower height, please refer to the paragraphs on working dimensions and installation).
- Check that the mains voltage corresponds to that indicated on the rating plate fixed to the inside of the hood.
- For Class I appliances, check that the domestic power supply guarantees adequate earthing.
Connect the extractor to the exhaust flue through a pipe of minimum diameter 120 mm. The route of the flue must be as short as possible.
- Do not connect the extractor hood to exhaust ducts carrying combustion fumes (boilers, fireplaces, etc.).
- If the extractor is used in conjunction with non-electrical appliances (e.g. gas burning appliances), a sufficient degree of aeration must be guaranteed in the room in order to prevent the backflow of exhaust gas. The kitchen must have an opening communicating directly with the open air in order to guarantee the entry of clean air. When the cooker hood is used in conjunction with appliances supplied with energy other than electric, the negative pressure in the room must not exceed 0,04 mbar to prevent fumes being drawn back into the room by the cooker hood.
- In the event of damage to the power cable, it must be replaced by the manufacturer or by the technical service department, in order to prevent any risks.

USE

- The extractor hood has been designed exclusively for domestic use to eliminate kitchen smells.
- Never use the hood for purposes other than for which it has been designed.
- Never leave high naked flames under the hood when it is in operation.
- Adjust the flame intensity to direct it onto the bottom of the pan only, making sure that it does not engulf the sides.
- Deep fat fryers must be continuously monitored during use: overheated oil can burst into flames.
- Do not flambè under the range hood; risk of fire
- This appliance is not intended for use by persons (including children) with reduced physical, sensory or mental capabilities, or lack of experience and knowledge, unless they have been given supervision or instruction concerning use of the appliance by a person responsible for their safety.
- Children should be supervised to ensure that they do not play with the appliance.
- "CAUTION: Accessible parts may become hot when used with cooking appliances."

MAINTENANCE

- Switch off or unplug the appliance from the mains supply before carrying out any maintenance work.
- Clean and/or replace the Filters after the specified time period (Fire hazard).
- Clean the hood using a damp cloth and a neutral liquid detergent.

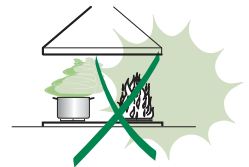
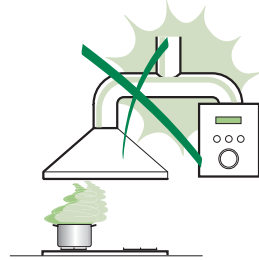

The symbol  on the product or on its packaging indicates that this product may not be treated as household waste. Instead it shall be handed over to the applicable collection point for the recycling of electrical and electronic equipment. By ensuring this product is disposed of correctly, you will help prevent potential negative consequences for the environment and human health, which could otherwise be caused by inappropriate waste handling of this product. For more detailed information about recycling of this product, please contact your local city office, your household waste disposal service or the shop where you purchased the product.

CHARACTERISTICS

Dimensions

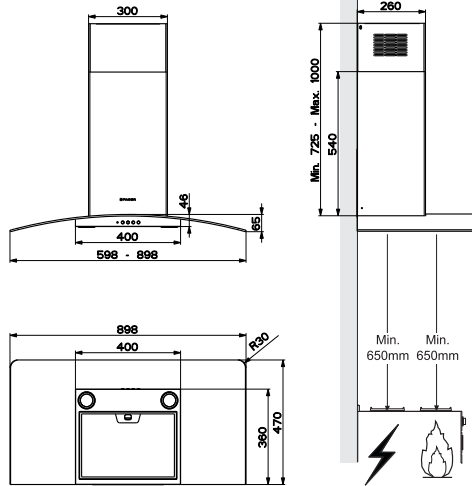

Components

Ref.	Q.ty	Product Components
1	1	Hood Body, complete with: Controls, Light, Blower, Filters
2	1	Telescopic Chimney comprising:
2.1	1	Upper Section
2.2	1	Lower Section
9	1	Reducer Flange \varnothing 150-120 mm
14.1	2	Air Outlet Connection Extension
15	1	Air Outlet Connection

Ref.	Q.ty	Installation Components
7.2.1	2	Upper Chimney Section Fixing Brackets
7.3	1	Air Outlet Connection Support
11	6	Wall Plugs
12a	6	Screws 4,2 x 44,4
12c	6	Screws 2,9 x 9,5

Q.ty	Documentation
1	Instruction Manual

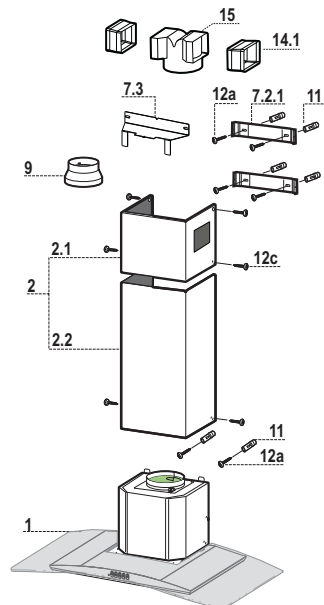

INSTALLATION

Wall drilling and bracket fixing

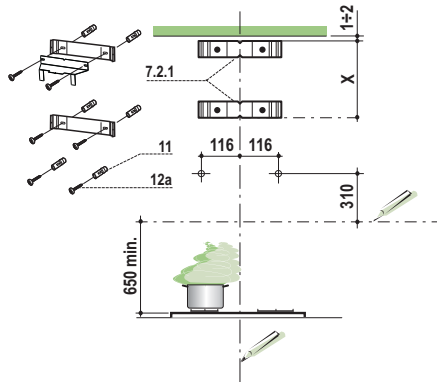

Wall marking:

- Draw a vertical line on the supporting wall up to the ceiling, or as high as practical, at the centre of the area in which the hood will be installed.
- Draw a horizontal line at 650 mm above the hob.
- Place bracket **7.2.1** on the wall as shown about 1-2 mm from the ceiling or upper limit aligning the centre (notch) with the vertical reference line.
- Mark the wall at the centres of the holes in the bracket.
- Place bracket **7.2.1** on the wall as shown at X mm below the first bracket (X = height of the upper chimney section supplied), aligning the centre (notch) with the vertical line.
- Mark the wall at the centres of the holes in the bracket.
- Mark a reference point as indicated at 116 mm from the vertical reference line and 310 mm above the horizontal reference line.
- Repeat this operation on the other side.
- Drill \varnothing 8 mm holes at all the centre points marked.
- Insert the wall plugs **11** in the holes.
- Fix the lower bracket **7.2.1** using the **12a** screws (4,2 x 44,4) supplied.
- Fix the upper bracket **7.2.1** and the air outlet connection support **7.3** together using the 2 screws **12a** (4,2 x 44,4) supplied.
- Insert the two screws **12a** (4,2 x 44,4) supplied in the hood body fixing holes, leaving a gap of 5-6 mm between the wall and the head of the screw.

Mounting the hood body

- Before attaching the hood body, tighten the two screws **Vr** located on the hood body mounting points.
- Hook the hood body onto the screws **12a**.
- Fully tighten the support screws **12a**.
- Adjust the screws **Vr** to level the hood body.

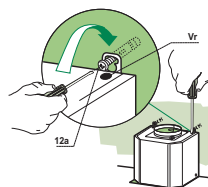

Connections

DUCTED VERSION AIR EXHAUST SYSTEM

When installing the ducted version, connect the hood to the chimney using either a flexible or rigid pipe \varnothing 150 or 120 mm, the choice of which is left to the installer.

- To install a \varnothing 120 mm air exhaust connection, insert the reducer flange **9** on the hood body outlet.
- Fix the pipe in position using sufficient pipe clamps (not supplied).
- Remove possible charcoal filters.

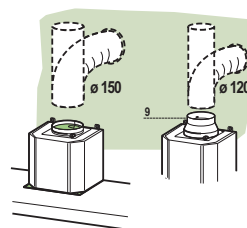

RECIRCULATION VERSION AIR OUTLET

- Insert the connection extension pieces laterally **14.1** in connection **15**.
- Insert the Connector **15** into the Support bracket **7.3** and fix it with a screw.
- Make sure that the outlet of the extension pieces **14.1** is horizontally and vertically aligned with the chimney outlets.
- Connect the air outlet connection **15** to the hood body outlet using either a flexible or rigid pipe \varnothing 150 mm, the choice of which is left to the installer.
- Ensure that the activated charcoal filters have been inserted.

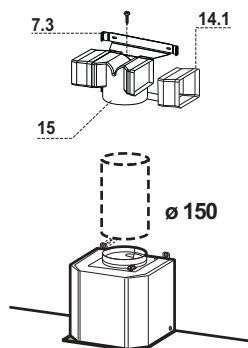

ELECTRICAL CONNECTION

- Connect the hood to the mains through a two-pole switch having a contact gap of at least 3 mm.
- Remove the grease filters (see paragraph Maintenance) being sure that the connector of the feeding cable is correctly inserted in the socket placed on the side of the fan.

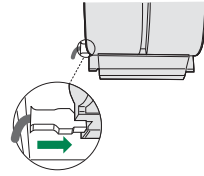

Flue assembly

Upper exhaust flue

- Slightly widen the two sides of the upper flue and hook them behind the brackets **7.2.1**, making sure that they are well seated.
- Secure the sides to the brackets by using the 4 screws **12c** (2,9 x 9,5) supplied.
- Make sure that the outlet of the extensions pieces is aligned with the chimney outlets.

Lower exhaust flue

- Slightly widen the two sides of the flue and hook them between the upper flue and the wall, making sure that they are well seated.
- Fix the lower part laterally to the hood body by using the 2 screws **12c** (2,9 x 9,5) supplied.

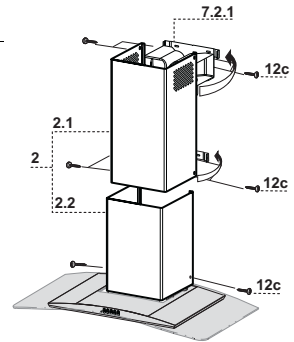

USE

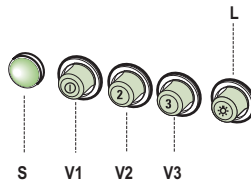

L	Light	Switches the lighting system on and off.
S	Led	Motor running led.
V1	Motor	Switches the extractor motor on and off at low speed. Used to provide a continuous and silent air change in the presence of light cooking vapours.
V2	Speed	Medium speed, suitable for most operating conditions given the optimum treated air flow/noise level ratio.
V3	Speed	Maximum speed, used for eliminating the highest cooking vapour emission, including long periods.

MAINTENANCE

Grease filters

CLEANING METAL SELF- SUPPORTING GREASE FILTERS

- The filters must be cleaned every 2 months of operation, or more frequently for particularly heavy usage, and can be washed in a dishwasher.
- Remove the filters one at a time by pushing them towards the back of the group and pulling down at the same time.
- Wash the filters, taking care not to bend them. Allow them to dry before refitting.
- When refitting the filters, make sure that the handle is visible on the outside.

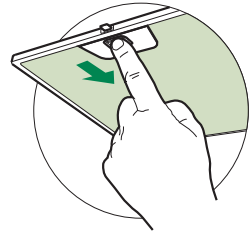

Activated charcoal filter (Recirculation version)

REPLACING THE ACTIVATED CHARCOAL FILTER

- The filter is not washable and cannot be regenerated, and must be replaced approximately every 4 months of operation, or more frequently for particularly heavy usage.
- Remove the metal grease filters.
- Remove the saturated activated carbon filter by releasing the fixing hooks.
- Fit the new filter by hooking it into its seating.
- Refit the metal grease filters.

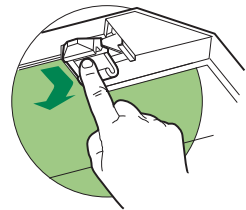

Lighting

LIGHT REPLACEMENT

20 W halogen light.

- Remove the snap-on lamp cover by levering it from under the metal ring, supporting it with one hand.
- Remove the halogen lamp from the lamp holder by pulling gently.
- Replace the lamp with a new one of the same type, making sure that you insert the two pins properly into the housings on the lamp holder.
- Replace the snap-on lamp cover.

