

PRECAUTIONS	30	USE	38
General safety instructions	30	Preliminary operations	38
For this appliance	33	Using the accessories	38
Appliance purpose	34	Using the oven	38
This user manual	34	Using the temperature probe (on some models only)	40
Manufacturer's liability	34	Cooking advice	43
Identification plate	35	Mini guide to accessories	44
Disposal	35	Discover the recipes	44
Information for European Control Bodies	35	CLEANING AND MAINTENANCE	44
Energy efficiency technical data	35	Cleaning the appliance	44
To save energy	35	Cleaning the door	44
Light sources	35	Cleaning the oven cavity	46
How to read the user manual	35	Pyrolytic (on some models only)	46
DESCRIPTION	36	Extraordinary maintenance	48
General description	36	INSTALLATION	49
Control panel	36	Electrical connection	49
Other parts	37	Positioning	50
Accessories	37		

We advise you to read this manual carefully, which contains all the instructions for maintaining the appliance's aesthetic and functional qualities. For further information on the product: www.smeg.com

PRECAUTIONS

General safety instructions

Risk of personal injury

- **ATTENTION:** during use, the appliance and its accessible parts become very hot. Children must be kept away from the appliance.
- **ATTENTION:** during use, the appliance and its accessible parts become very hot. Never touch the heating elements during use.
- Protect your hands by wearing oven gloves when moving food inside the oven.
- Never try to put out a fire or flames with water: turn off the appliance and smother the flames with a fire blanket or other appropriate cover.
- This appliance may be used by children aged at least 8 and by people of reduced physical, sensory or mental capacity, or lacking in experience in the use of electrical appliances, provided that they are supervised or instructed by adults who are responsible for their safety.
- Children must not play with the appliance.
- Keep children under the age of 8 at a safe distance unless they are constantly supervised.
- Keep children under the age of 8 away from the appliance when it is in use.

- Cleaning and maintenance must not be carried out by unsupervised children.
- The cooking process must always be monitored. A short cooking process must be continuously surveyed.
- Never leave the appliance unattended during cooking operations where fats or oils could be released, as these could then heat up and catch fire. Be very careful.
- Do not pour water directly onto very hot trays.
- Keep the oven door closed during cooking.
- If you need to move food or at the end of cooking, open the door 5 cm for a few seconds, let the steam come out, then open it fully.
- Do not insert pointed metal objects (cutlery or utensils) into the slots in the appliance.
- Switch off the appliance immediately after use.
- DO NOT USE OR STORE FLAMMABLE MATERIALS NEAR THE APPLIANCE.
- DO NOT USE AEROSOLS IN THE VICINITY OF THIS APPLIANCE WHILST IT IS IN USE.
- DO NOT MODIFY THIS APPLIANCE.
- Installation and servicing should be carried out by qualified personnel in accordance with current standards.
- Do not try to repair the appliance yourself or without the assistance of a qualified technician.
- Do not pull the cable to unplug the appliance.

Risk of damaging the appliance

- Do not use abrasive or corrosive detergents (e.g. scouring powders, stain removers and metallic sponges), rough or abrasive materials or sharp metal scrapers on glass parts as this could cause scratch the surface and break the glass. Use wooden or plastic utensils.
- Do not sit on the appliance.
- Do not use cleaning products containing chlorine, ammonia or bleach on parts made of steel or that have metallic surface finishes (e.g. anodizing, nickel- or chromium-plating).
- Racks and trays should be inserted as far as they will go into the side guides. The mechanical safety locks that prevent them from being removed must face downwards and towards the back of the

oven cavity.

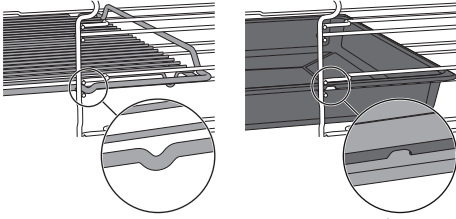

- Do not use steam jets to clean the appliance.
- Do not spray any spray product near the appliance.
- Do not obstruct ventilation openings and heat dispersal slots.
- Fire hazard: never leave objects in the oven cavity.
- **DO NOT FOR ANY REASON USE THE APPLIANCE AS A SPACE HEATER.**
- Do not use plastic cookware or containers when cooking food.
- Do not place sealed tins or containers in the oven cavity.
- Remove all trays and racks which are not required during cooking.
- Do not cover the bottom of the oven cavity with aluminium or tin foil sheets.
- Do not place pans or trays directly on the bottom of the oven cavity.
- If necessary, you can use the tray rack (supplied or sold separately, depending on the model) by placing it on the bottom as a support for cooking.
- If you wish to use greaseproof

paper, place it so that it will not interfere with the hot air circulation inside the oven cavity.

- Do not use the open door to rest pans or trays on the internal glass pane.
- Never use the oven door to lever the appliance into place when fitting.
- Avoid exerting too much pressure on the door when open.
- Do not use the handle to lift or move this appliance.

For pyrolytic appliances

- When the pyrolytic function is in use, the surfaces could reach temperatures that are higher than usual. Keep children at a safe distance.
- Before starting the pyrolytic cycle, remove any food residues or large spills from previous cooking operations from the inside of the oven.
- Before starting the pyrolytic cycle, remove all accessories from the oven cavity.
- Before starting the pyrolytic cycle, switch off the burners or electric hot plates of the hob installed above the oven.

Installation and maintenance

- **THIS APPLIANCE MUST NOT BE INSTALLED IN A BOAT OR CARAVAN.**

- The appliance must not be installed on a pedestal.
 - Position the appliance into the cabinet cut-out with the help of a second person.
 - To prevent any possible overheating, the appliance should not be installed behind a decoration door or a panel.
 - Installation and servicing should be carried out by qualified personnel in accordance with current standards.
 - Have the electrical connection performed by authorised technical personnel.
 - The appliance must be connected to earth in compliance with electrical system safety standards.
 - Use cables withstanding a temperature of at least 90 °C.
 - The tightening torque of the screws of the terminal supply wires must be 1.5 - 2 Nm.
 - If the power cable becomes damaged, contact technical support immediately to arrange for it to be replaced in order to avoid possible hazards.
 - **WARNING:** while positioning the appliance, make sure that the power supply cable is not caught or damaged.
 - Always use any necessary/required personal protective equipment (PPE) before performing any work on the appliance (installation, maintenance, positioning or movement).
 - Before performing any work on the appliance, switch off the power supply.
 - Allow the appliance to be disconnected after installation, via an accessible plug or a switch in the case of a fixed connection.
 - Fit the power line with an all-pole circuit breaker with a contact separation distance sufficient to provide complete disconnection in category III overvoltage conditions, pursuant to installation regulations.
 - **WARNING:** Make sure that the appliance has been switched off and disconnected from the mains power supply or that the mains power has been switched off before replacing the interior lighting bulbs.
 - The bulbs used in this appliance are specific for household appliances; do not use them for home lighting.
 - This appliance can be used up to a maximum altitude of 2,000 metres above sea level.
- For this appliance**
- Do not rest any weight or sit on the open door of the appliance.
 - Take care that no objects are stuck in the doors.

- Do not install/use the appliance outdoors.
- (on some models only) Only use the temperature probe provided or recommended by the manufacturer.

Temperature probe (if present)

- Do not touch the rod or the tip of the temperature probe after use.
- Wear oven gloves when handling the temperature probe.
- Take care not to scratch or damage enamelled or chrome-plated surfaces with the tip or the plug of the temperature probe.
- Do not insert the temperature probe into openings and slots on the appliance.
- When the temperature probe is not in use, make sure that the protective metal cap is properly closed.
- Do not pull the cable to remove the temperature probe from the socket or from the food.
- Make sure that the temperature probe or its cable do not get caught in the door.
- Make sure that the temperature probe or its cable do not come into contact with heating elements inside the oven.
- No part of the temperature probe should be allowed to come into contact with the walls

of the oven cavity, the heating elements, the racks or the trays when they are still hot.

- The probe should not be kept inside the appliance.
- Do not use the temperature probe during the pyrolytic cycle.

Appliance purpose

This appliance is intended for cooking food in the home environment. Every other use is considered inappropriate. It cannot be used:

- in employee kitchens, shops, offices and other working environments.
- in farms/farmhouses.
- by guests in hotels, motels and residential environments.
- In bed and breakfast accommodation.

This user manual

- This user manual is an integral part of the appliance and must therefore be kept in its entirety and within the user's reach for the whole working life of the appliance.
- Read this user manual carefully before using the appliance.
- The explanations in this manual include images, which describe all that regularly appears on the display. However, it should be kept in mind that the appliance may be equipped with an updated version of the system, and as such, all that appears on the display may differ from those in the manual.

Manufacturer's liability

The manufacturer declines all liability for damage to persons or property caused by:

- use of the appliance other than that specified;
- failure to comply with the instructions in the user manual;

- tampering with any part of the appliance;
- use of non-original spare parts.

Identification plate

The identification plate bears the technical data, serial number and brand name of the appliance. Do not remove the identification plate for any reason.

Disposal



This appliance conforms to the WEEE European directive (2012/19/EU) and must be disposed of separately from other waste at the end of its service life.

The appliance does not contain substances in quantities sufficient to be considered hazardous to health and the environment, in accordance with current European directives.



Power voltage Danger of electrocution

- Disconnect the mains power supply.
- Unplug the appliance.

To dispose of the appliance:

- Cut the power cable and remove it.
- Deliver the appliance to the appropriate recycling centre for electrical and electronic equipment waste, or return it to the retailer when purchasing an equivalent product, on a one for one basis.

Our appliances are packaged in non-polluting and recyclable materials.

- Deliver the packing materials to the appropriate recycling centre.



Plastic packaging Danger of suffocation

- Do not leave the packaging or any part of it unattended.
- Do not let children play with the plastic bags.

Information for European Control Bodies

Fan forced mode

the ECO function used to define the energy efficiency class complies with the specifications of European standard EN 60350-1.

Energy efficiency technical data

Information in accordance with the European

91477A143/C

energy labelling and ecodesign regulations is contained in a separate document accompanying the product instructions.

These data are present in the "Product information sheet" that can be downloaded from the website at the page dedicated to the product in question.

To save energy

- Only preheat the appliance if the recipe requires you to do so.
- Unless otherwise indicated on the package, defrost frozen foods before placing them in the oven.
- When cooking several types of food it is recommended to cook the foods one after the other to make the best use of the already hot oven.
- Use dark metal moulds: They help to absorb the heat better.
- Remove all trays and racks which are not required during cooking.
- Stop cooking a few minutes before the time normally used. Cooking will continue for the remaining minutes with the heat which has accumulated inside the oven.
- Reduce any opening of the door to a minimum to avoid heat dispersal.
- Keep the inside of the oven clean at all times.

Light sources

- This appliance contains user-replaceable light sources.

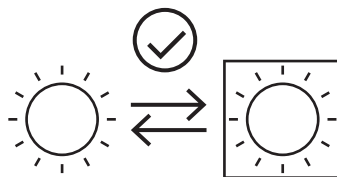

- The light sources contained in the appliance are declared suitable for operation at ambient temperature $\geq 300^{\circ}\text{C}$ and intended for use in high temperature applications such as ovens.
- This appliance contains light sources of efficiency class "G".

How to read the user manual

This user manual uses the following reading



DESCRIPTION

General description

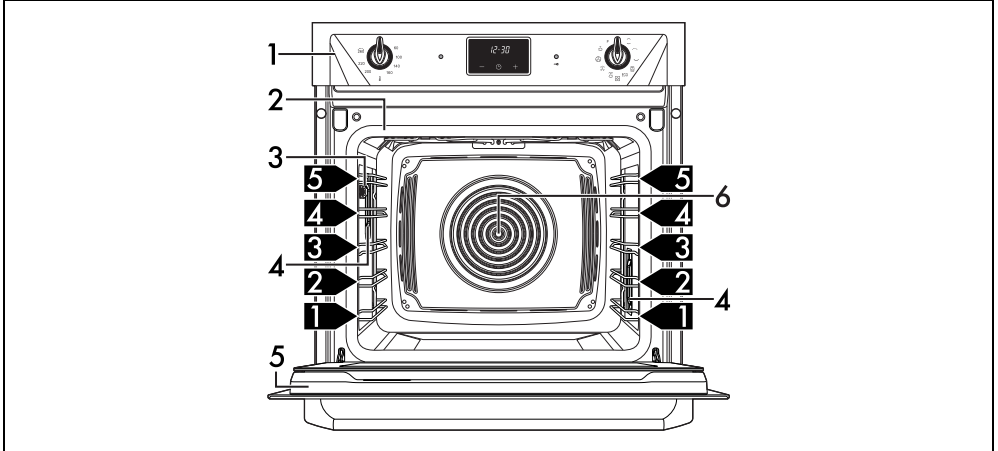

1 Control panel

2 Seal

3 Temperature probe socket (on some models only)

4 Light bulb

5 Door

6 Fan

1,2,3 → Frame shelf

Control panel

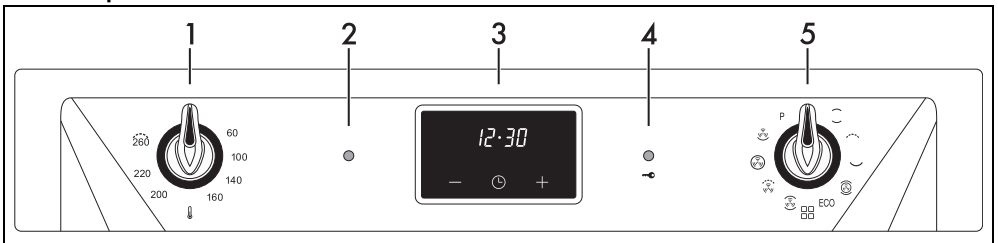

1 Temperature knob

This knob allows you to select the cooking temperature.

Turn the knob clockwise to the required value, between the minimum and maximum setting.

2 Thermostat indicator light

The indicator light comes on to indicate that the oven is heating up. It turns off as soon as it reaches the set temperature. Turning on and off regularly indicates that the temperature set inside the oven cavity is being kept constant.

3 Digital programmer

Useful for displaying the current time, setting programmed cooking operations and programming the minute minder timer.

4 Pyrolytic function indicator light

It comes on when the automatic (pyrolytic function) cleaning cycle is activated.

5 Function knob

The oven's various functions are suitable for different cooking methods. After selecting the required function, set the cooking temperature

using the temperature knob.

Other parts

Shelves

The appliance features shelves to position trays and racks at different heights. The insertion heights are indicated from the bottom upwards.

Cooling fan

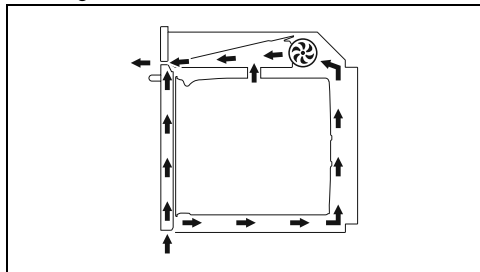

The fan cools the appliance and comes into operation during cooking.

The fan causes a steady outflow of air from above the door which may continue for a short period of time even after the appliance has been turned off.

Oven lighting

The appliance's interior lighting comes on:

- when the door is opened (on some models only).
- when any function is selected, apart from ECO function (where present).



(on some models only) When the door is open, it is not possible to turn off the interior lighting.

Accessories



Not all accessories are available on some models.



The accessories intended to come into contact with food are made of materials that comply with the provisions of current legislation.



Original supplied and optional accessories can be requested to Authorised Assistance Centres. Use only original accessories supplied by the manufacturer.

Rack

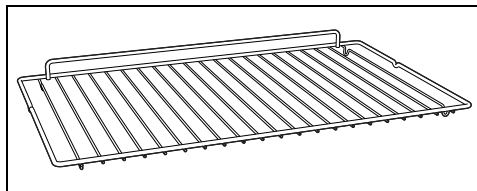

Used for supporting containers with food during cooking.

Deep tray

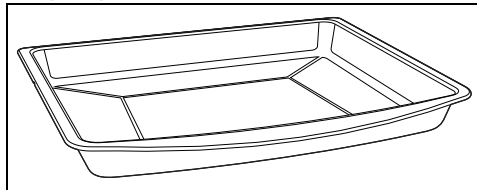

Useful for collecting fat from foods placed on the rack above and for cooking pies, pizzas, baked desserts, biscuits, etc.

Protective cover (on some models only)

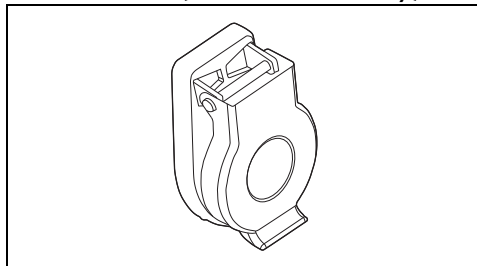

Used to cover and protect the temperature probe socket when the temperature probe is not in use.

Temperature probe (on some models only)

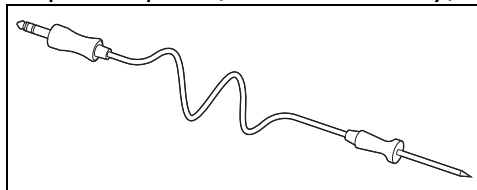

With the temperature probe, you can cook according to the temperature measured at the centre the food.

USE

Preliminary operations



See General safety instructions.

- Remove any protective film from the outside or inside of the appliance, including accessories.
- Remove any labels (apart from the technical data plate) from the accessories and shelves.
- Remove and wash all the appliance accessories (see chapter "CLEANING AND MAINTENANCE").

First heating

1. Set a cooking time of at least one hour (see paragraph "Using the oven").
2. Heat the empty oven compartment at the maximum temperature to burn off any residues left by the manufacturing process.

When heating the appliance

- air the room;
- don't stay.

Using the accessories

Racks and trays

Racks and trays have to be inserted into the side guides until they come to a complete stop.

- The mechanical safety locks that prevent the rack from being removed accidentally must face downwards and towards the back of the oven cavity.

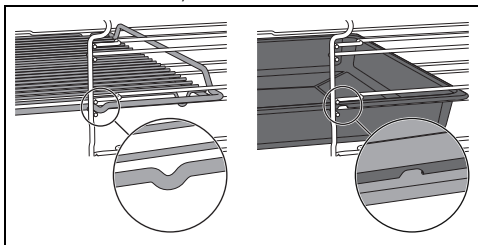

Gently insert racks and trays into the oven until they come to a stop.



Clean the trays before using them for the first time to remove any residues left by the manufacturing process.

Using the oven



See General safety instructions.

Digital programmer

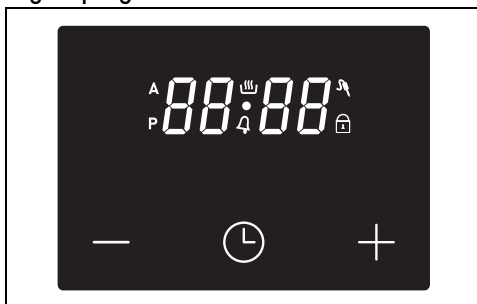

 Decrease key

 Clock key

 Increase key

Display symbols

 Timed cooking

 Pyrolytic cycle

 Cooking

 Minute minder timer

 Temperature probe





 Door lock

Setting the time





If the time is not set, the oven will not switch on.

On the first use, or after a power failure, the digits  will be flashing on the appliance's display.

1. Hold the clock button  down for a few seconds. The dot between the hours and the minutes flashes.
2. The time can be set via the increase key  and decrease key . Keep the button pressed to increase or decrease rapidly.
3. Press the clock key  or wait for a few seconds.

The dot between the hours and the minutes stops flashing.

 To change the time, hold down the increase key  and decrease key  at the same time for two seconds, then set the time.

Oven switching-on (manual cooking)

 Depending on the recipe, the food can be placed in the oven cavity either immediately or after preheating.

To switch on the oven:

1. Select the cooking function using the function knob.
2. Select the temperature using the temperature knob.

After a few seconds, the cooking stage starts.

Preheating stage

Cooking itself is preceded by a preheating stage, which allows the appliance to heat to the cooking temperature more quickly.

This stage is indicated by the thermostat indicator light switching on and the symbol  flashing on the display.

At the end of preheating:

- the thermostat indicator light switches off;
- the symbol  on the display remains steadily lit;
- the appliance beeps;
- cooking starts automatically.

Once preheating is complete, the food can be placed in the oven cavity (if provided for in the recipe).

End of a manual cooking

To end a cooking:

- Turn the function knob and/or the temperature knob to the 0 position.



Minute minder timer

 The minute minder timer does not stop the cooking operation but rather informs the user when the set time has run out.



The minute minder timer can be activated at any time.

1. Press the clock key .

The display shows the text .

2. Use the increase  and decrease  keys to set the required minutes.
3. Press the clock  key or wait for a few seconds to activate the Minute minder timer function.

The current time and the symbol  will appear on the display.

 Press the clock  key to see the remaining time on the display.

At the end of the minute minder timer time:

- the symbol  flashes;
- a buzzer sounds, which can be switched off by pressing any key on the display.

 The minute minder timer can be set from 1 minute to a maximum of 23 hours and 59 minutes.

Timed cooking

 Timed cooking is the function which allows a cooking operation to be started and then ended after a specific length of time set by the user.

1. Select a cooking function using the function knob.
2. Select a temperature using the temperature knob.
3. Press the clock  key or wait for a few seconds to start the preheating stage.

4. Press the clock key .

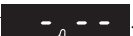
the display shows the values for setting the minute minder timer .

5. Press the clock key  again.

On the display the flashing  symbol and the text  appear, alternating with the current time.

6. Use the increase  and decrease  keys to set the required minutes of cooking.

 It is not possible to set a cooking time of more than 13 hours.

7. Press the clock  key or wait for a few seconds to activate the function.

The current time and the  and  symbols

will appear on the display.



To reset the set programming, turn the function knob and/or the temperature knob to the 0 position.

At the end of cooking:

- the heating elements are deactivated;
 - a buzzer sounds, which can be switched off by pressing any key on the display;
 - the flashing text **A End** appears on the display.
8. Press the clock button to reset the programmer clock.
 9. Turn the function knob and/or the temperature knob to position 0 to exit the function.

Programmed cooking



Programmed cooking is the function which allows a cooking operation to be started at a set time and then ended after a specific length of time set by the user.

1. After selecting the cooking function and temperature using the appropriate knobs, set a timed cooking as described in the previous paragraph.
2. Press the clock key .

The text **A End** will appear on the display in sequence with the pre-set cooking duration added to the current time.

3. Press the or key to set the cooking end time.



It is not possible to set a programmed cooking time of more than 24 hours.



Bear in mind that a few minutes for the preheating stage must be added to the cooking time.

4. Press the clock key or wait for a few seconds to activate the function.

The current time appears and the and symbols light up on the display.

The appliance waits to start cooking and

finishes at the time set by the user.



To reset the set programming, turn the function knob and/or the temperature knob to the 0 position.

At the end of cooking:

- the heating elements are deactivated;
 - a buzzer sounds, which can be switched off by pressing any key on the display;
 - the flashing text **A End** appears on the display.
5. Press the clock button to reset the programmer clock.
 6. Turn the function knob and/or the temperature knob to position 0 to exit the function.

Modifying the set data

1. Press the clock key until the type of data to be changed is selected (minute minder timer - timed cooking programmed cooking).
A dur
A End
2. Use the increase and decrease keys to change the wished data.

Selecting the buzzer

The buzzer can have 3 tones.

1. Hold down the increase and decrease keys at the same time until hearing the buzzer.

2. Press the clock key .

Press the decrease key to select a different buzzer tone, among **ton1**, **ton2** and **ton3**.

Using the temperature probe (on some models only)



See General safety instructions.

The temperature probe enables you to cook roasts, loin steaks and other cuts and sizes of meat with great precision. The probe ensures that the food is perfectly cooked by monitoring the core temperature of the food. The core temperature is measured by a sensor inside the

tip of the probe.



Do not install any telescopic guides on the fourth shelf from the bottom, as they would not allow access to the temperature probe side socket.

Positioning the probe

1. Place the food on a tray.
2. Insert the tip of the probe into the food before you place it in the oven.
3. For best results, make sure that the temperature probe is placed transversely in the thickest part of the food and for least 3/4 of its length. Make sure that it does not touch the tray underneath and that it does not protrude from the food.

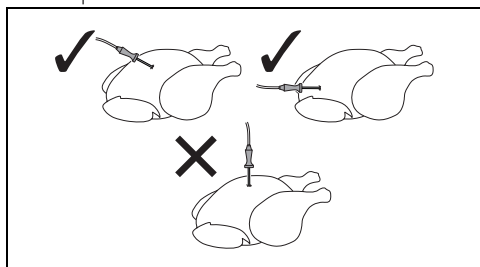

In order for the probe to measure the core temperature of the food precisely, its tip must not be in contact with bones or fat.



The recommended minimum temperature for cooking with the probe is 120°C, with the exception of slow temperature cooking.

Setting cooking parameters when using the temperature probe



Attention: during use, the accessible parts become very hot. Protect your hands with heat-proof gloves when connecting the temperature probe and when handling food inside the oven cavity.



The temperature range that can be selected is from a minimum of 40°C to a maximum of 90°C.



If the temperature of the oven is set too low, the appliance automatically sets the minimum temperature necessary in order to reach the selected target temperature.



For best results, it is recommended to set a cooking temperature higher than the target temperature.



If, while cooking using the temperature probe, for any reason it is necessary to disconnect the probe without using the knobs or the display, the function proceeds as normal cooking.

With cold oven:

1. Turn the function knob to select the required function.
2. Open the oven door.
3. Insert the tray on which the food has been placed into the appropriate guides.
4. Insert the plug of the temperature probe into the socket at the side, using the probe to open the protective cover.

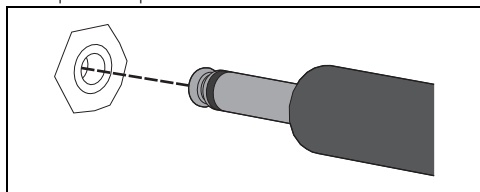

5. Close the door.

The display shows **75 °C** (75°C is the proposed default target temperature).

6. Use the increase **+** and decrease **-** keys to set the target temperature.

Press the clock **⌚** key or wait a few seconds to start the preheating stage, followed

automatically by the cooking stage.

With cooking started:

1. Turn the function knob to select the required function.
2. Turn the temperature knob to set the cooking temperature.

Press the clock  key or wait for a few seconds to start the preheating stage.

At the end of preheating:

3. Open the oven door.
4. Insert the tray on which the food has been placed into the appropriate guides.
5. Insert the plug of the temperature probe into the socket at the side, using the probe to open the protective cover.
6. Close the door.

The display shows  (75°C is the proposed default target temperature).

7. Use the increase  and decrease  keys to set the target temperature.

After a few seconds, the cooking with probe starts.

Cooking end with the temperature probe

Cooking ends when the appliance reaches the target temperature set by the user.

Heating elements are turned off, the appliance beeps and the display shows the message



1. Open the door.
2. Remove the probe from the food and unplug it from the socket.
3. Remove the food from the oven.
4. Make sure that the protective cover is properly closed.
5. Close the door.

List of traditional cooking functions

 Not all functions are available on some models.

STATIC

 Traditional cooking suitable for the preparation of one dish at a time. Ideal for cooking roasts, fatty meats, bread, pies.

GRILL



It allows to obtain excellent grilling and grating results. Used at the end of cooking, it gives a uniform browning to the dishes.

BASE



The heat only comes from the bottom of the cavity. Perfect for cakes, pies, tarts and pizzas.

TURBO



Allows quick cooking on multiple shelves without mixing the aromas. Perfect for large volumes that call for intense cooking.

ECO

ECO

This function is particularly suitable for cooking on a single shelf with low energy consumption. It is recommended for all types of food, excluding those that can create a lot of humidity (such as vegetables). To obtain maximum energy savings and reduce cooking times, it is recommended to place food in the oven without preheating.



When using the ECO function, avoid opening the door during cooking.



In the ECO function cooking times (and any preheating) are longer and may depend on the amount of food in the cooking compartment.



The ECO function is a delicate cooking function and is recommended for food withstanding temperatures lower than 210°C; in case of cooking at higher temperatures, select another function.

FAN-ASSISTED



Intense and uniform cooking. Ideal for biscuits, cakes and multilevel cooking.

FAN-ASSISTED GRILL



Allows optimal grilling of even the thickest meats. Perfect for large cuts of meat.

THERMALLY-VENTILATED



The heat is distributed quickly and evenly. Suitable for all dishes, ideal for cooking on several levels without mixing odours and flavours.

FAN-ASSISTED BASE



This function is particularly suitable for cooking on a single shelf with low energy consumption.

It is recommended for all types of food, excluding those that can create a lot of humidity (such as vegetables).

To obtain maximum energy savings and reduce cooking times, it is recommended to place food in the oven without preheating.

For the **P** PYROLYTIC function, see the chapter **CLEANING AND MAINTENANCE**.

Cooking advice

General advice

- Use a fan assisted function to achieve consistent cooking at several levels.
- It is not possible to shorten cooking times by increasing the temperature (the food could be overcooked on the outside and undercooked on the inside).

Advice for cooking meat

- Cooking times vary according to the thickness and quality of the food and to consumer taste.
- Use a meat thermometer when roasting meat, or simply press on the roast with a spoon. If it is hard, it is ready; If not, it needs another few minutes cooking.

Advice for cooking with the Grill and the Fan with grill

- Meat can be grilled even when it is put into the cold oven or into the preheated oven if you wish to change the effect of the cooking.
- When using the fan-assisted with grill function, we recommend that you preheat the oven before grilling.
- We recommend placing the food at the centre of the rack.
- With the Grill function, we recommend that you set the temperature to the maximum value to optimise cooking.

Advice for cooking desserts/pastries and biscuits

- Use dark metal moulds: They help to absorb the heat better.
- The temperature and the cooking time depend on the quality and consistency of the dough.
- To check whether the dessert is cooked right through: At the end of the cooking time, put a toothpick into the highest point of the dessert. If the dough does not stick to the toothpick, the dessert is cooked.
- If the dessert collapses when it comes out of the oven, on the next occasion reduce the set temperature by about 10°C, selecting a longer cooking time if necessary.

Advice for defrosting and proving

- Place frozen foods without their packaging in a lidless container on the first shelf of the oven.
- Avoid overlapping the food.
- To defrost meat, use the rack placed on the second level and a tray on the first level. In this way, the liquid from the defrosting food drains away from the food.
- The most delicate parts can be covered with aluminium foil.
- For successful proving, a container of water should be placed in the bottom of the oven.

To save energy

- Stop cooking a few minutes before the time normally used. Cooking will continue for the remaining minutes with the heat which has accumulated inside the oven.
- Reduce any opening of the door to a minimum to avoid heat dispersal.
- Keep the inside of the appliance clean at all times.

Mini guide to accessories



Rack

We recommend the use of the grill as a support surface for baking moulds/casseroles.

In the absence of the baking tray grill, the grill can be used as a base for grilling with the deep baking tray placed on a shelf below to collect the juices.



Deep tray

We recommend the use of the deep baking tray for cooking on one level only.

Place the deep baking tray on the centre shelf when using the fan-assisted functions. When

using the STATIC function  place the deep baking tray on the required shelf.

Place the baking tray on the last shelf with the baking tray grill to cook in GRILL mode .

Discover the recipes

To consult the recipes developed for various categories of food and to get more information

on cooking suggestions, we recommend visiting the dedicated page on the www.smeg.com website, which can be reached using the QR code on the leaflet supplied with the product.

CLEANING AND MAINTENANCE

Cleaning the appliance



See General safety instructions.

Cleaning the surfaces

To keep the surfaces in good condition, they should be cleaned regularly after use. Let them cool first.

Ordinary daily cleaning

Always and only use specific products that do not contain abrasives or chlorine-based acids. Pour the product onto a damp cloth and wipe the surface, rinse thoroughly and dry with a soft cloth or a microfibre cloth.

Food stains or residues

Do not use steel sponges and sharp scrapers as they will damage the surface.

Use normal, non-abrasive products and a wooden or plastic tool, if necessary. Rinse thoroughly and dry with a soft cloth or a microfibre cloth.

Do not allow residues of sugary foods (such as jam) to set inside the oven. If left to set for too long, they might damage the enamel lining of the oven.

Cleaning the door

Door disassembly

For easier cleaning it is recommended to remove the door and place it on a tea towel.

To remove the door proceed as follows:

1. Open the door completely and insert two pins into the holes on the hinges indicated in the figure.

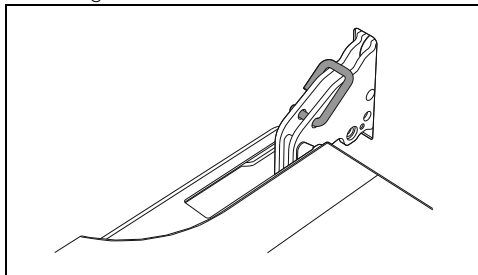

2. Grasp the door on both sides with both hands, lift it forming an angle of around 30° and remove it.

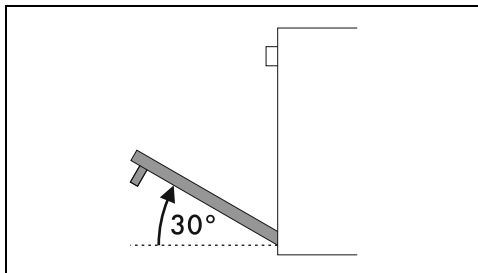

3. To reassemble the door, put the hinges in the relevant slots in the oven, making sure

that grooved sections **A** are resting completely in the slots.

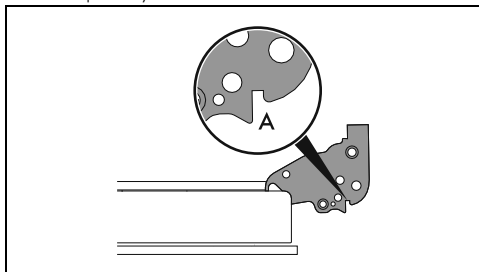

4. Lower the door and once it is in place remove the pins from the holes in the hinges.

Cleaning the door glazing

The glass in the door should always be kept thoroughly clean. Use absorbent kitchen roll. In case of stubborn dirt, wash with a damp sponge and an ordinary detergent.

Removing the internal glass panes

For easier cleaning the internal glass panes of the door can be removed.

1. Lock the door with the appropriate pins.
2. Remove the internal glass pane by pulling the rear part gently upwards, following the movement indicated by the arrows 1.

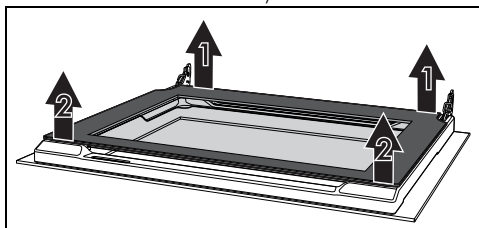

3. Release the front pins following the movement indicated by the arrows 2
4. Then remove the inner glass pane from the front profile.

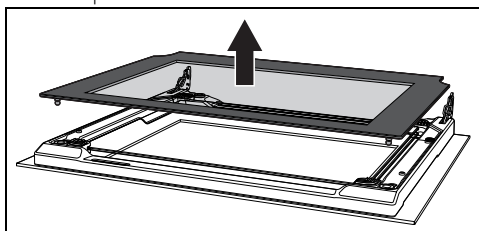

5. Pull the intermediate glass unit downwards from the door and then lift it upwards.

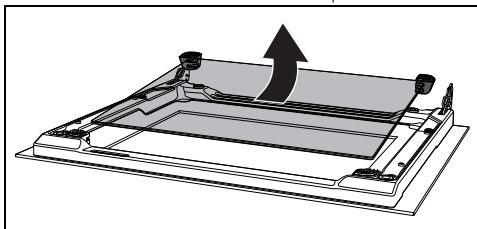

Note: In some models, the intermediate glass unit consists of two panes.

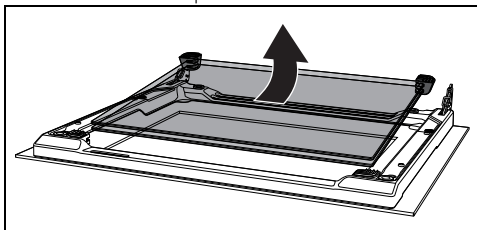

During this step, the upper grommets may come out of their seats.

6. Insert the front grommets into their seats. The feet of the grommets must be facing the outer glass

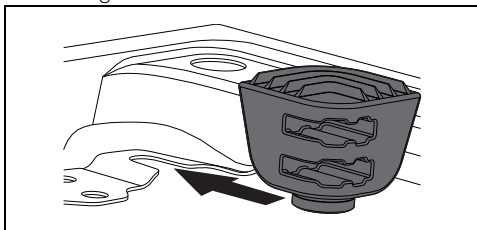

7. Clean the external glass pane and the panes removed previously.

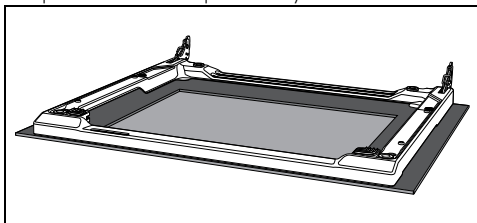

8. Use absorbent kitchen roll. In case of stubborn dirt, wash with a damp sponge and neutral detergent.

- Reinsert the intermediate glass unit and reposition the inner glass.

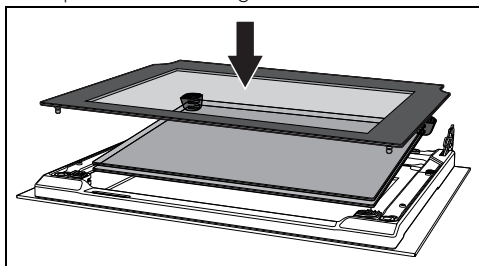

The intermediate glass pane must be repositioned on the open door so that the screen printing in the corner can be read from left to right (the rough part of the screen printing must face the external glass pane of the door).

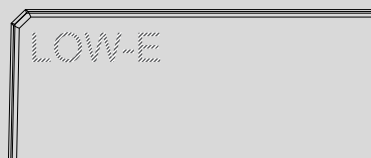

- Be sure to fit the 4 pins of the inner glass well into their seats on the door.

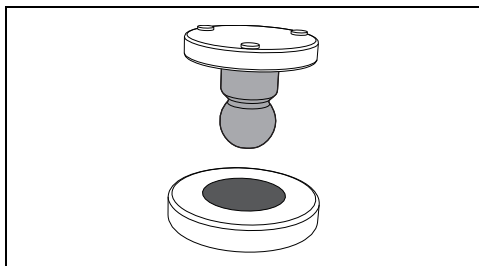

Cleaning the oven cavity

In order to keep your oven in the best possible condition, clean it regularly after letting it cool down.

Avoid letting food residue dry inside the oven cavity, as this could damage the enamel.

Take out all removable parts before cleaning. For easier cleaning, it is recommended to remove:

- the door;

- The rack/tray support frames.



In the event you are using specific cleaning products, we recommend running the oven at maximum temperature for 15-20 minutes in order to eliminate any residue.

Drying

Cooking food generates moisture inside the appliance. This is a normal phenomenon and does not affect the appliance's operation in any way.

Each time you finish cooking:

- Let the appliance cool down.
- Remove any dirt from inside the appliance.
- Dry the interior of the appliance with a soft cloth.
- Leave the door open until the inside of the appliance has dried completely.

Removing racks/trays support frames

Removing the rack/tray support frames enables the sides to be cleaned more easily.

To remove the rack/tray support frames:

- Pull the frame towards the inside of the oven cavity to unhook it from its groove A, then slide it out of the seats B at the back.

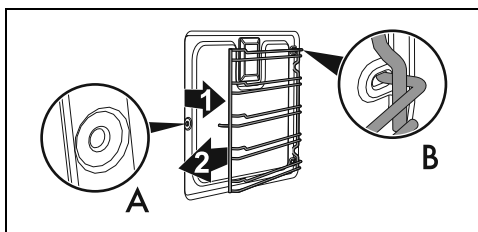

- When cleaning is complete, repeat the above procedures to put the rack/tray support frames back in.

Pyrolytic (on some models only)



See General safety instructions.



Pyrolytic cleaning is an automatic high-temperature cleaning procedure which causes dirt to dissolve. This process makes it possible to clean the inside of the oven very easily.

Preliminary operations

Before starting the pyrolytic cycle:

- Clean the internal glass pane following the usual cleaning instructions.

- Remove any food residues or large spills from previous cooking operations from the inside of the oven.
- Completely remove all accessories from inside the oven.
- For very stubborn encrustations spray an oven cleaning product onto the glass (read the warnings on the product); leave for 60 minutes, then rinse and dry the glass using kitchen roll or a microfibre cloth.
- If present, remove the temperature probe.
- Remove the rack/tray support frames.
- Close the door.

Pyrolytic function setting

1. Turn the function knob to the position **P**.

The display shows the **A dur** text alternated with the Pyrolytic cycle duration (factory set to 2 hours and 30 minutes).

2. Use the increase  and decrease  keys to set the Pyrolytic cycle duration.

 Recommended pyrolytic cycle duration:

- Light dirt: 2:00
- Medium dirt: 2:30
- Heavy dirt: 3:00

3. Press the clock  key to confirm the data entered.

After a few seconds, the preheating of the Pyrolytic cycle starts:

- the symbol **P** on the display and the Pyrolytic cycle indicator light switch on;
- the display shows the time left until the end of the entire cleaning process **P 2:29**;
- the symbol  on the display flashes.



A few minutes after the preheating starts, the  symbol comes on (steadily lit) to indicate that the door is locked by a device that prevents the door from being opened.

 It is not possible to select any function once the door lock device has been activated.

 If the function knob is turned to another function, the display shows an error message **Er 04**.

Cleaning process

At the end of preheating, the Pyrolytic cycle starts automatically:

- the thermostat indicator light turns off (turning on and off regularly indicates that the temperature inside the oven cavity is being kept constant);
- on the display, the  symbol comes on (steadily lit) to indicate that the Pyrolytic cycle is in progress;
- The Pyrolytic cycle indicator light and the **P** and  symbols on the display remain lit.



During the first Pyrolytic cycle, unpleasant odours may occur due to the normal evaporation of oily manufacturing substances. This is an absolutely normal phenomenon which disappears after the first pyrolytic cycle.





During the Pyrolytic cycle the fans produce a more intense level of noise due to a greater rotation speed. This is an absolutely normal operation, intended to provide more effective heat dispersal. At the end of the pyrolytic cycle, the fans will continue to operate for long enough to avoid overheating the walls of adjacent units and the front of the oven.

End of Pyrolytic function

At the end of the Pyrolytic function:

- the heating elements are deactivated;
 - the flashing text **P End** appears on the display;
 - a buzzer sounds, which can be switched off by pressing any key on the display;
 - the symbol  and the thermostat indicator light switch off.
1. Turn the function knob to position 0 to exit the function.

The symbol  on the display remains lit until the temperature inside the oven cavity returns to safe levels (with the consequent deactivation of the door lock).

2. Wait for the oven cavity to cool down.
3. After the  symbol switches off, open the door and collect the residue deposited

inside the oven cavity with a damp microfibre cloth.



We recommend wearing rubber gloves for these operations.



For easier manual cleaning of parts that are difficult to reach, we recommend removing the door.



If the pyrolytic cycle gives unsatisfactory results at minimum duration, it is recommended to set a longer time for subsequent cleaning cycles.

Programmed Pyrolytic function



Like for the cooking functions, it is also possible to set an end time for the Pyrolytic function.

To set a programmed Pyrolytic function:

1. Turn the function knob to the position **P**.

The text **dur** alternated with the duration of the Pyrolytic cycle **2:30** will appear on the display.

2. Use the increase **+** and decrease **-** keys to set the Pyrolytic cycle duration.
3. Press the clock key **🕒**.

The text **End** will appear on the display alternated with the previously set Pyrolytic function duration added to the current time.

4. Press the **-** or **+** key to set the function end time.
5. Press the clock **🕒** key or wait for a few seconds to activate the function.

The display shows the current time and the symbol **P** flashes to indicate that the appliance is waiting to start the Pyrolytic function and will finish at the time set by the user.

Extraordinary maintenance

Seal maintenance tips

The seal should be soft and elastic.

- To keep the seal clean, use a non-abrasive sponge and wash with lukewarm water.

Replacing the internal light bulb



Power voltage
Danger of electrocution

- Unplug the appliance.
 - Wear protective gloves.
1. Completely remove all accessories from inside the oven.
 2. Remove the rack/tray support frames.
 3. Use a tool (e.g. a spoon) to remove the bulb cover.

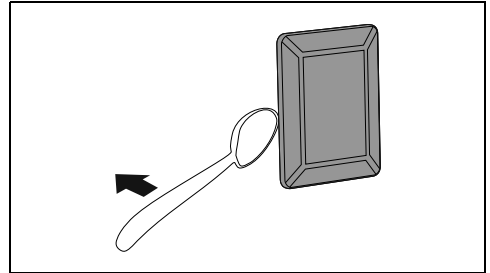

Take care not to scratch the enamel of the oven cavity wall.

4. Slide out and remove the light bulb.

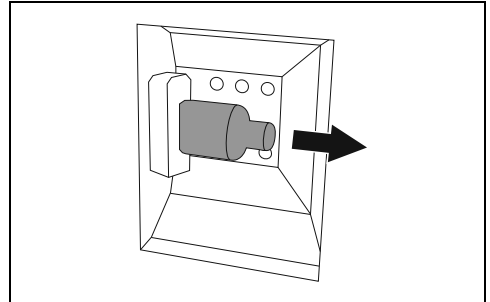

Do not touch the halogen light bulb directly with your fingers, use an insulating material.

5. Replace the light bulb with one of the same type (40 W).

6. Refit the cover. Ensure the moulded part of the glass (A) is facing the door.

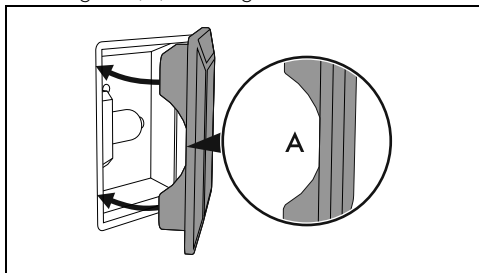

7. Press the cover completely down so that it attaches perfectly to the bulb support.

INSTALLATION

Electrical connection



See General safety instructions.

General information

Check the mains characteristics against the data indicated on the plate.

The identification plate bearing the technical data, serial number and brand name is visibly positioned on the appliance.

Do not remove this plate for any reason.

The appliance must be connected to ground using a wire that is at least 20 mm longer than the other wires.

The appliance can work in the following modes:

- 220-240 V~

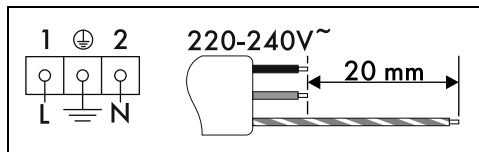

3 x 1.5 mm² three-core cable.



The values indicated above refer to the cross section of the internal lead.



The aforementioned power cables are sized taking into account the coincidence factor (in compliance with standard EN 60335-2-6).

Fixed connection

Fit the power line with an all-pole circuit breaker with a contact separation distance sufficient to provide complete disconnection in category III overvoltage conditions, pursuant to installation

regulations.

For the Australian/New Zealand market:

The circuit breaker incorporated in the fixed connection must comply with AS/NZS 3000.

Connection with plug and socket

Make sure that the plug and socket are of the same type.

Avoid using adapters, gang sockets or shunts as these could cause overheating and a risk of burns.

Cable replacement



Power voltage
Danger of electrocution

- Disconnect the mains power supply.

1. Unscrew the rear casing screws and remove the casing to access the terminal board.

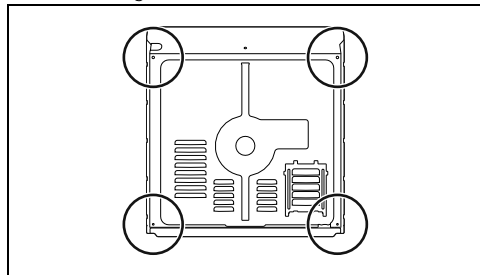

2. Replace the cable.
3. Make sure that the cables (for the oven or any hob) follow the best route in order to avoid any contact with the appliance.

Positioning



See General safety instructions.

Position of the power cable

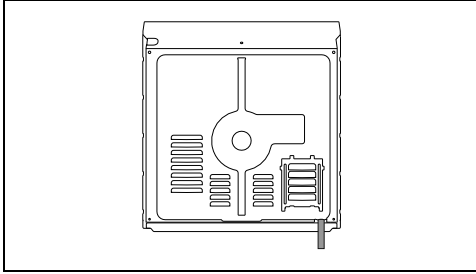

Front panel seal

Glue the supplied seal to the rear part of the front panel to avoid water or other liquids from leaking in.

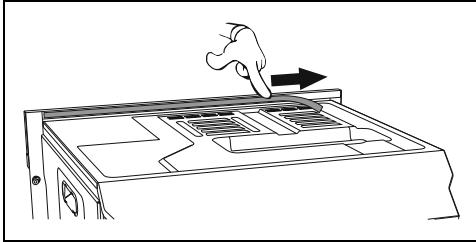

Fastening bushings

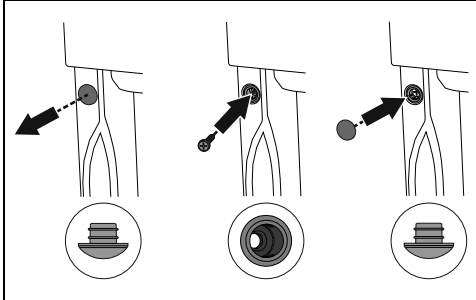

1. Remove the bushing covers on the front of the appliance.
2. Mount the appliance into the recess.
3. Secure the appliance to the cabinet using screws.
4. Cover the bushings with the previously removed covers.

Appliance overall dimensions (mm)

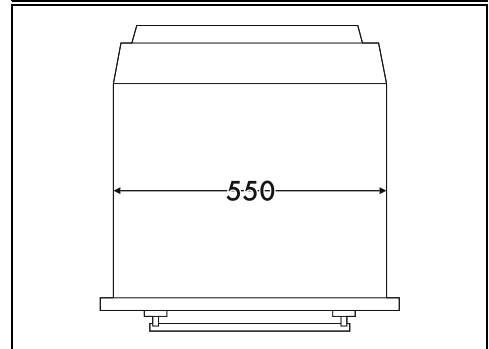
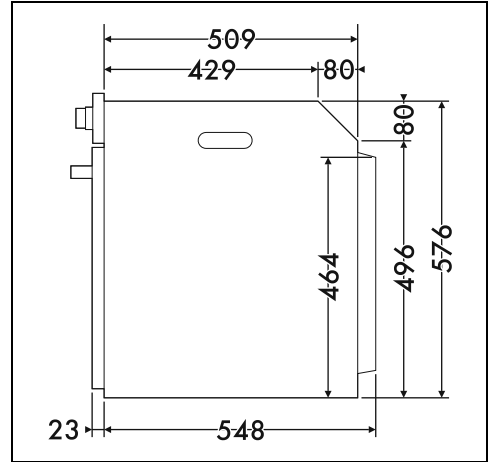
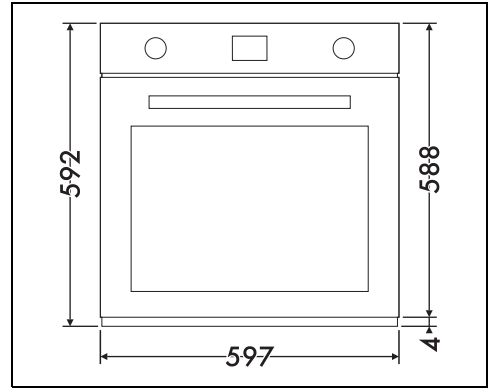

Mounting into a column (mm)

EN

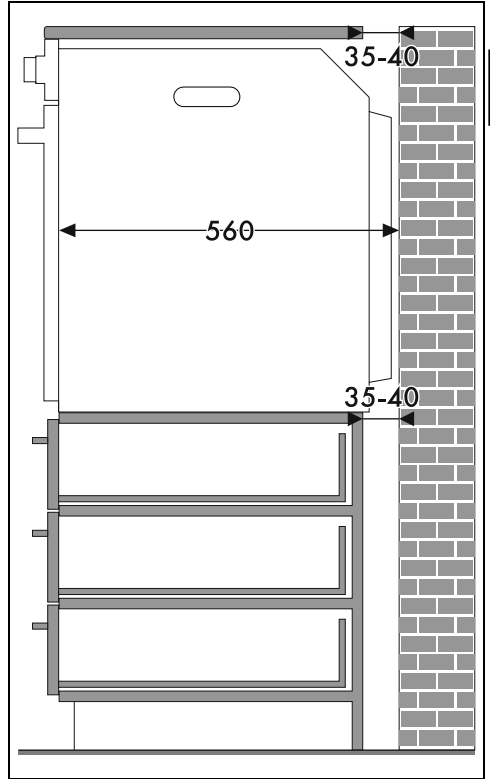
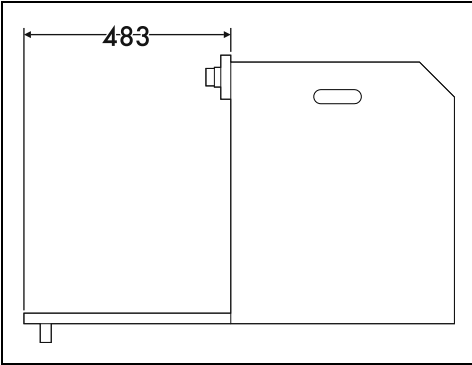
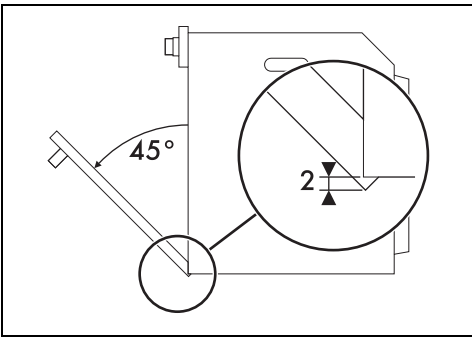

* Make sure that the cabinet top/rear section has an opening approx. 35-40 mm deep.

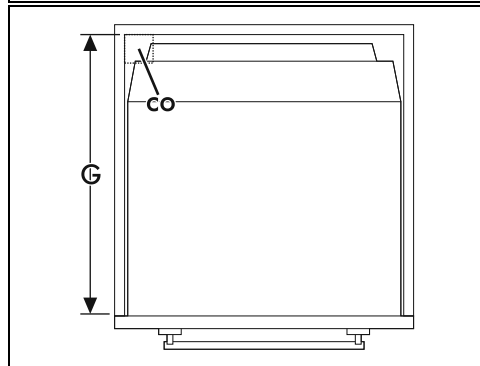
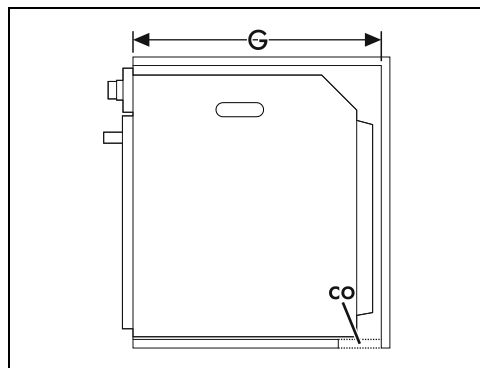
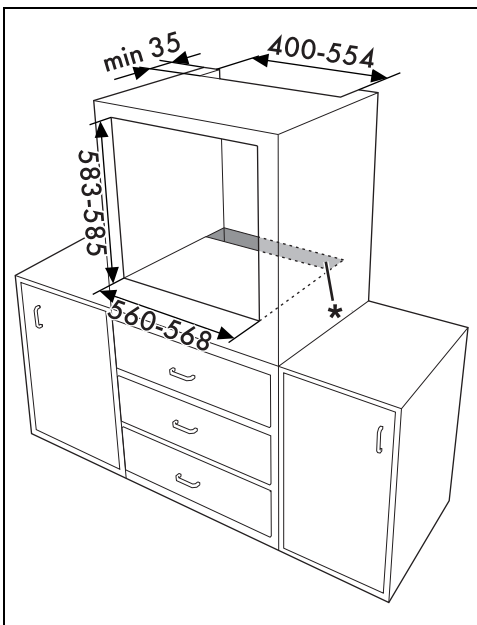

A min. 603 mm

B 560 - 568 mm

C 583 - 585 mm

D 9 - 11 mm

E min. 5 mm

F 121 - 1105 mm

G min. 560 mm

H min. 594 mm

co Cutout for power cord (min. 6 cm²)

jb Electrical connection box

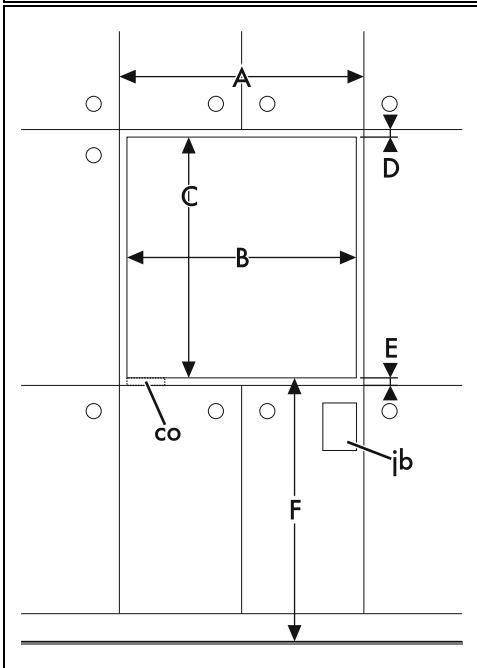

Mounting under worktops (mm)

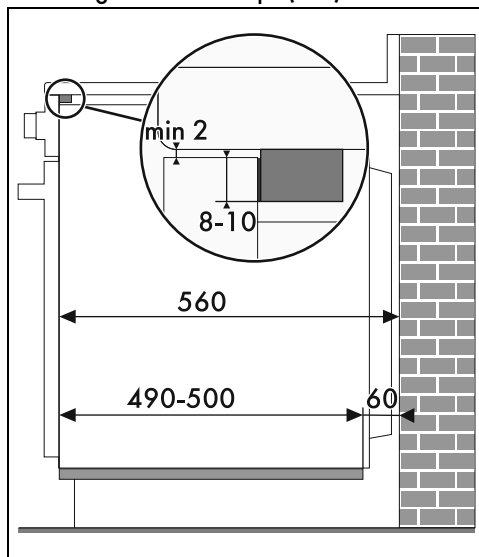

 If the appliance is to be built-in under a worktop, a wooden bar has to be installed order to use the seal that is glued to the back of the front panel to prevent water or other liquids leaking in.

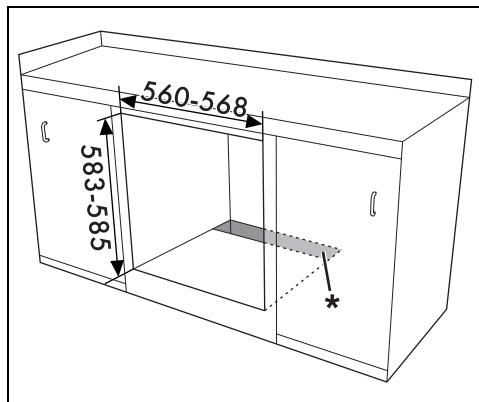

 * Make sure that the piece of furniture top/rear part has an opening approx. 60 mm deep.

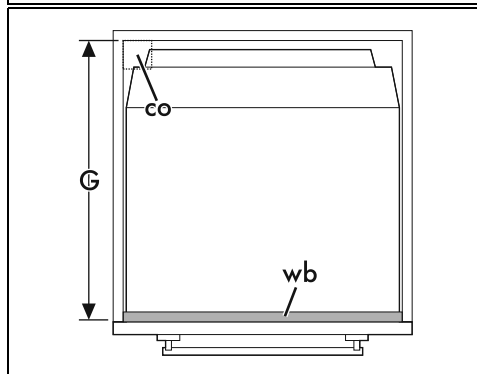
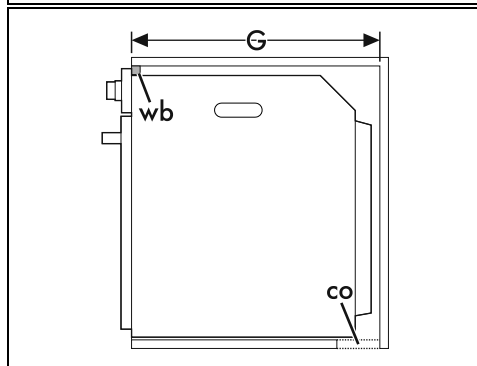
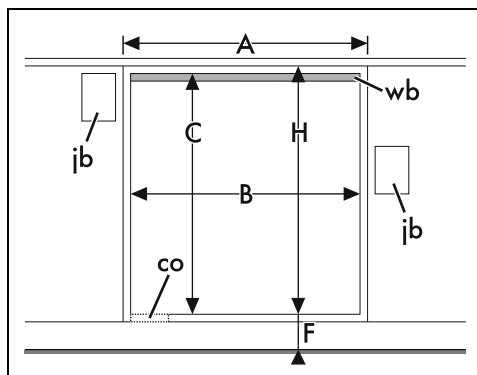

EN

A min. 603 mm

B 560 - 568 mm

C 583 - 585 mm

D 9 - 11 mm

E min. 5 mm

F 121 - 1105 mm

G min. 560 mm

H min. 594 mm

co Cutout for power cord (min. 6 cm²)

jb Electrical connection box

wb Wooden bar (recommended)

Mounting under worktops (mm) (pyrolytic models only)

Whenever a hob is installed above the oven, a wooden separator has to be installed at a minimum distance of 20 mm from the top of the oven to prevent overheating when the two appliances are used at the same time. It must only be possible to remove the separator by using suitable tools.

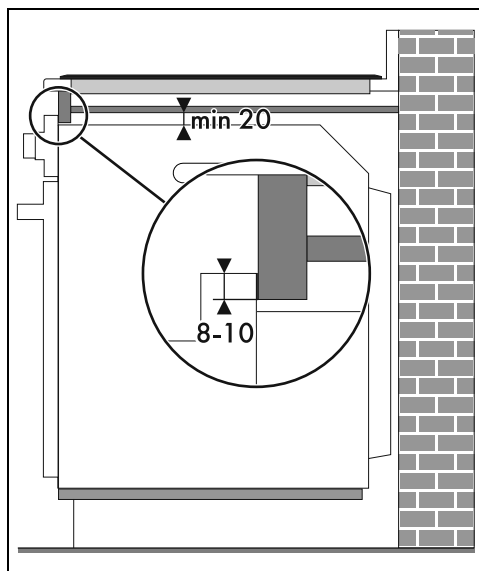
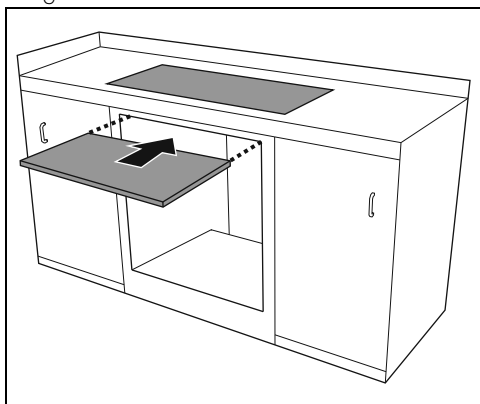

When using a wooden separator, a wooden bar has to be installed under the worktop in order to use the seal that is glued to the back of the front panel to prevent water or other liquids leaking in.