

SE263TD1



Product Family	Hob
Built-in type	Ultra-low profile or Fully Flushed
Dimensions	60 cm
Power supply	Electric
Type	Ceramic
EAN code	8017709312046



Aesthetics



Colour	Black
Finishing	Glass
Aesthetics	Universale
Material	Glass
Glass type	Ceramic
Glass edge	Straight edge
Type of control setting	Digi Touch
LED colours	Red
Control knob position	Front
Serigraphy colour	Grey

Programme / Functions

Total no. of cook zones	3
No. of ceramic cook zones	3
Main on/off switch	Yes
Power levels	9

Options



Worktop Cut-Out	490x560 mm	Residual time indicator	Yes
End cooking timer	3	Showroom Demo Option	Yes
Minute minder	1	Control Lock / Child Safety	Yes
End of cooking alarm	Yes		

Technical Features



Rear-left - Ceramic - Single - 1.80 kW - Ø 18.0 cm

Front-left - Ceramic - Single - 1.20 kW - Ø 14.5 cm

Centre-right - Ceramic - Double - 2.40 kW - Ø21.0 - Ø 27.0 cm

Automatic switch off when overheat Yes

Residual heat indicator Yes

Automatic switch off when overflow Yes

Electrical Connection

Electrical connection rating (W) 5400 W
Current 25 A
Voltage (V) 220-240 V
Voltage 2 (V) 380-415 V

Type of electric cable Single and Double phase
Frequency (Hz) 50/60 Hz
Power supply cable length 130 cm
Terminal box 4 poli

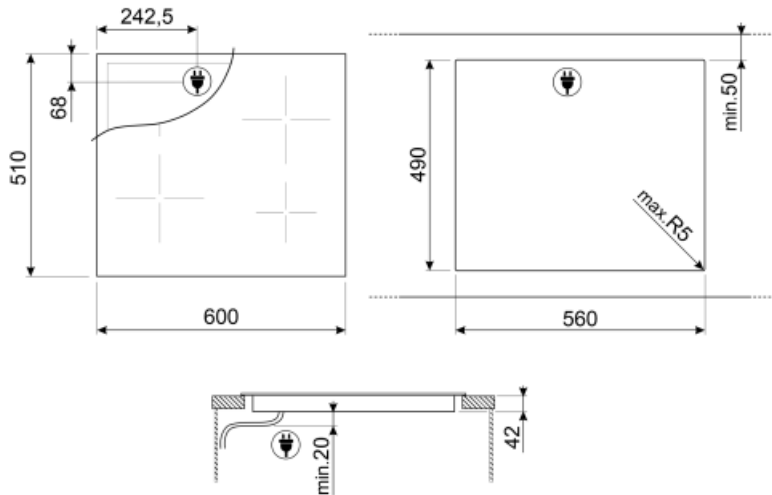









Not included accessories



SCRP

Non-scratch hob scraper - suitable for induction and ceramic hobs

Symbols glossary (TT)

	Child lock: some models are fitted with a device to lock the programme/cycle so it cannot be accidentally changed.		Overheat protection: The safety system that automatically turns off the hob in case of overheating of the control unit.
	Glass ceramic: The base of the hob is made glass ceramic. Heating is performed by the heating elements Hi-Light.		Overfill protection: The special overfill protection shuts down the stove in the presence of overflow of liquids.
	Indication of residual heat: After the glass ceramic hob is switched off the residual heat indicator shows which of the heating zones still remains hot. When the temperature drops below 60 ° C, the indicator goes out.		Time elapsed: shows how long the cooking zone has been in use.
	Timer: All ceramic hobs have a timer which automatically ends cooking after a preset time.		Touch control